

# Multifunction Devices CIM1, CIM12, CIM13, CIM14

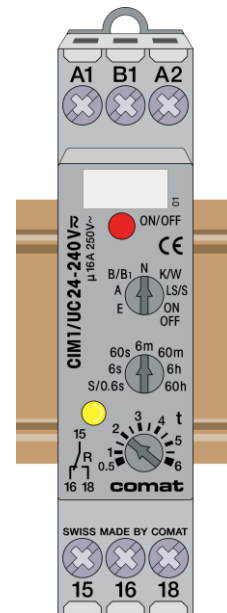

## 1 Features

- Power supply AC and DC 24 ... 240 V, 16 ... 63 Hz
- 1 Change-over contact 16 A or Semiconductor output 1.2 A AC or 4 A DC
- 8 timer functions: E, A, B, B1, N, K, LS and W
- Staircase lighting relay
- Stepping switch
- 7 time ranges from 50 ms to 60 h
- Service function ON/OFF with push button
- LED output status display
- Railway versions available
- Commutation at zero crossing (50/60 Hz)

## 2 General description

The CIM1, CIM12, CIM13, CIM14 are compact and multifunctional timer relays with 9 functions and 7 time intervals from 50 ms to 60 hours. This relays are suitable for applications as step-on-step-off relays, staircase lighting relays and as multifunction timer relays. They were developed for a voltage range of UC 24-240V and they are able to switch nominal current up to 16 A at a nominal voltage of 240 V. Solid-state outputs for 1.2 A, 250 V AC (CIM12) and 4 A, 24 V DC (CIM13) are available.

The CIM1x complies with the applicable DIN standards 43880 at an installation dimension of 17.5 mm.

Due to its wide range of application, the product reduces the inventory requirement of various different types.

**Technical specification is subject to change without previous notice**

## 3 Order designation

Comat Multifunction Device	CIM1/UC24-240V	(Relay)
	CIM1R/UC24-240V	(Relay, Railway)
	CIM12/UC24-240V	(Solid-State AC Output)
	CIM12R/UC24-240V	(Solid-State AC Output, Railway)
	CIM13/UC24-240V	(Solid-State DC Output)
	CIM13R/UC-24-240V	(Solid-State DC Output, Railway)
	CIM14/UC24-240V	(Relay, High Inrush current)

## 4 Connection diagram

Input - Function:

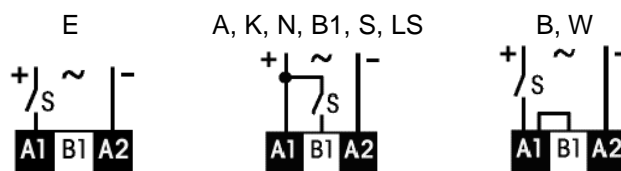

Output - Type:



## 5 Function descriptions

### 5.1 ON delayed (E)

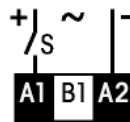
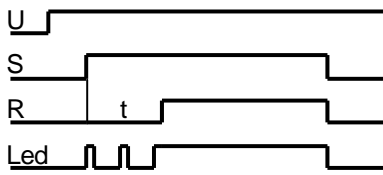

By triggering (S)  $\uparrow$ , the output R is switched ON according to the set time t.

### 5.2 Blinker (B) (B1)

#### 5.2.1 Blinker (B), Setting: B/B1

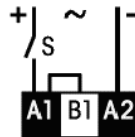
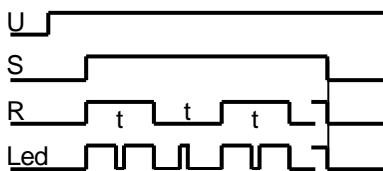

By triggering (S)  $\uparrow$ , the output R is switched ON/OFF according to the set time t. The output will be stopped at the same time as (S).

#### 5.2.2 Blinker (expiring impulse) (B1), Setting: B/B1

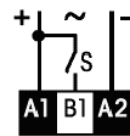
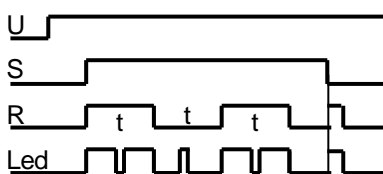

By triggering (S)  $\uparrow$ , the output R is switched ON/OFF according to the set time t. The last impulse is always completed according the selected time t.

### 5.3 One shot (K/W)

#### 5.3.1 Pulse shaping (K), Setting: K/W

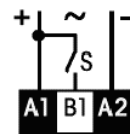
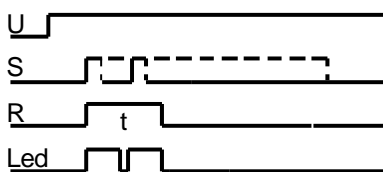

By triggering (S)  $\uparrow$ , the output R is switched ON for the set time t. The output impulse is independent of the duration of the trigger.

#### 5.3.2 One shot raising edge (W), Setting: K/W

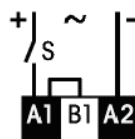
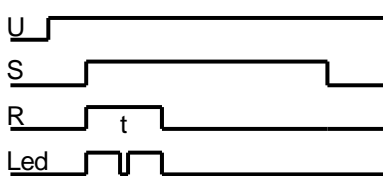

By triggering (S)  $\uparrow$ , the output R is switched ON for the set time t. In case of a premature triggering (S)  $\downarrow$ , the output impulse stops immediately.

### 5.4 OFF delayed (A)

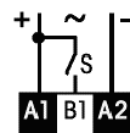
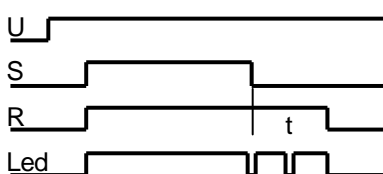

By triggering (S)  $\uparrow$ , the output R is switched ON. With falling edge (S) the output R is switched OFF after the set time t.

**5.5 One shot falling edge (N)**

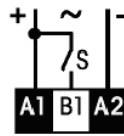
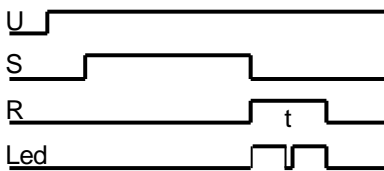

With falling edge (S) of the triggering, the output R is switched ON for the set time t. If during the timing the trigger (S) is activated, R will be OFF.

**5.6 Stepping switch (S)**

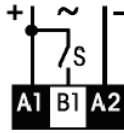
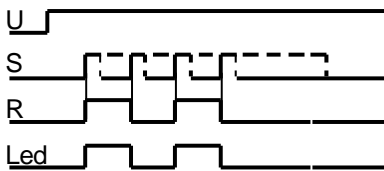

By triggering (S)↑ or pushing the red button, the state of R is changed.

**5.7 Staircase function (LS)**

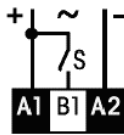
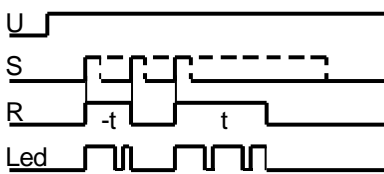

By triggering (S)↑, the state of R is changed. If the time between two impulses of S is longer than the selected time t, R is switched OFF.

**5.8 Relay On/Off (ON/OFF)**

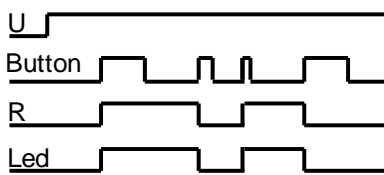

Relay ON/OFF, independent of the trigger B1. Eventually working time functions are interrupted. By pushing the button, the relay is switched ON or OFF.

## 6 Specifications

### 6.1 General Data

#### 6.1.1 Mechanical Data

Outside dimension	System DIN, W x H x D: 17.5 x 75 x 64 mm
Connector	Screw terminal 2.5 mm <sup>2</sup>
Max. screw tightening torque	0.4 Nm
Protection	IP20
Case material	Lexan EXL9330
Weight	approx. 70 g
Fastening	TS35 DIN/EN 60715 or screw fastening M4

#### 6.1.2 Ambient conditions

Storage temperature	-40 °C ... +85 °C
Operating temperature	-40 °C ... +60 °C (Railway: -40 °C ... +70 °C)
Relative humidity	10 % ... + 95 % (not condensed)

#### 6.1.3 Life cycle

Life cycle	> 100 000 h (at 25 °C)
------------	------------------------

(Relay contacts: see Point 6.4 Output circuit)

### 6.2 Electrical Data

#### 6.2.1 Supply U<sub>B</sub> (A1 – A2)

Nominal operating voltage (AC/DC)	24 ... 240 V
Operating voltage (AC/DC)	16.8 ... 250 V
Frequency range	16 ... 63 Hz
Power consumption	≤ 23 mA
Inrush current	≤ 2.5 A, τ = 100 μs
Power consumption	AC: ≤ 1.2 VA; DC: ≤ 430 mW

#### 6.2.2 Input control, U<sub>S</sub> (B1)

Control voltage range (AC/DC)	16.8 ... 250 V
Response level (AC/DC)	13 V / 15 V
Power consumption	≤ 22 mA
Cut off current (DC)	≤ 0.5 mA
Glow lamp current (AC)	< 10 mA
Hysteresis	approx. 1 V

### 6.3 Time response

#### 6.3.1 Time ranges

*The time ranges should be adjusted by the tuning button in the ratio 0.5 ....6.*

Time ranges	50 ms ... 0.6 s
	0.5 s ... 6 s
	5 s ... 60 s
	0.5 min ... 6 min
	5 min ... 60 min
	0.5 h ... 6 h
	5 h ... 60 h

Time range tolerance	t min	-5% ... +0%
	t max	-0% ... +5%

### 6.3.2 Time dependence

Voltage stability	≤ 1% over the whole range
Temperature stability	≤ 2% over the whole range
Maximal variation under interferences described in chapter 9.	≤ 5%

### 6.3.3 Other time data

Supply trigger time (Start-up time)	≤ 45 ms
Min. input delay (AC/DC)	≥ 20 ms
Reset time control input (AC/DC)	≤ 40 ms
Reset time power supply (AC/DC)	≤ 50 ms
Power supply protection 50/60 Hz	≥ 20 ms
Response delay (B1)	≤ 30 ms
Repetition accuracy	± 0.1%
or	DC: 2 ms    AC: ± 10 ms

### 6.4 Output circuit

	Relay	Solid-state AC	Solid-state DC	Relay for high inrush current
Typ	CIM1, CIM1R	CIM12, CIM12R	CIM13, CIM13R	CIM14
Output	C.O.	N.O.	N.O.	N.O.
Commutation at zero crossing (* Only for time ranges > 0.6 s)	Yes*	Yes	No	Yes*
Nominal current at 40 °C	16 A	2 A	5 A	16 A
Nominal current at 60 °C	13 A	1.2 A	4 A	13 A
Inrush current	30 A / 10 ms	100 A / 10 ms	40 A / 10 us	165 A / 20 ms 800 A / 200 us
Nominal voltage	250 V	250 V AC	24 V DC	250 V
Switching power AC-1	4000 VA	300 VA	-	4000 VA
Switching power DC-1	384 W	-	96 W	384 W
Contact material	AgNi 90/10	Triac	MOSFET	W / AgSnO <sub>2</sub>
Recommended minimal load	10 mA	50 mA	1 mA	100 mA
Leakage current	-	1 mA	10 µA	-
Voltage drop	-	1.1 V	300 mV	-
I <sup>2</sup> t	-	78 A <sup>2</sup> s	-	-
Short-circuit strength	-	No	No	-
Life time of contacts	50 x 10 <sup>3</sup> (16 A, 250 V AC-1)	∞	∞	5 x 10 <sup>3</sup> (16 A, 250 V AC-1)
Mechanical life time	30 x 10 <sup>6</sup>	-	-	5 x 10 <sup>6</sup>
Voltage stability Excitation – Contact			2.5 kV (RMS, 1 min.)	

### 6.5 Typical performance characteristics

CIM1, CIM1R, CIM14 - Breaking capacity

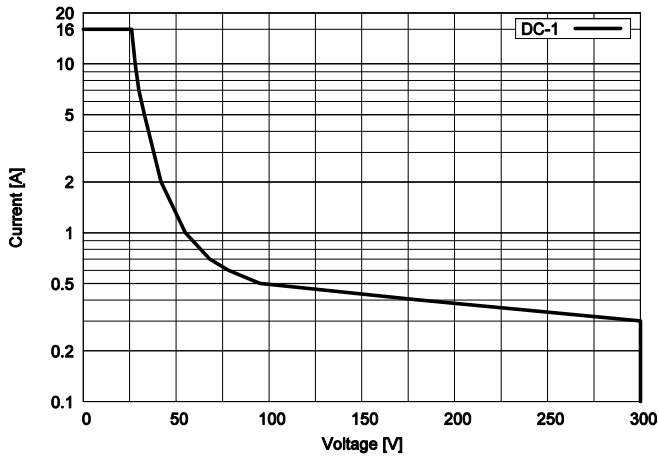

CIM1, CIM1R - Electrical endurance

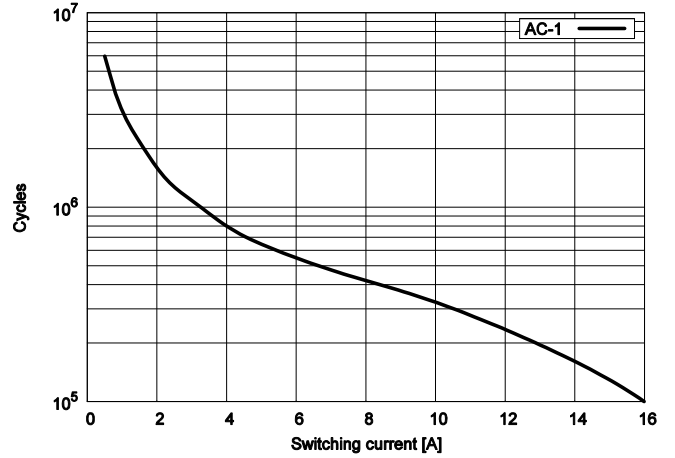

CIM1, CIM1R, CIM14 - Output current

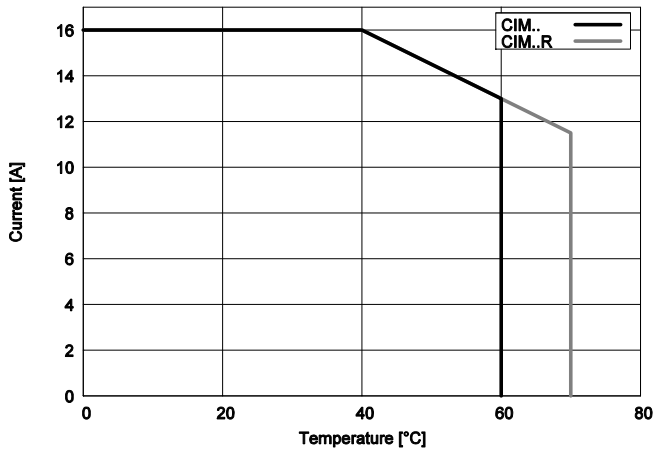

CIM12, CIM12R - Output current

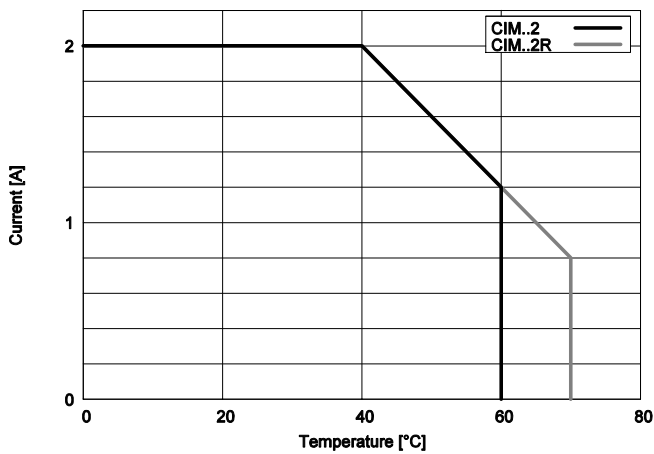

CIM13, CIM13R - Output current

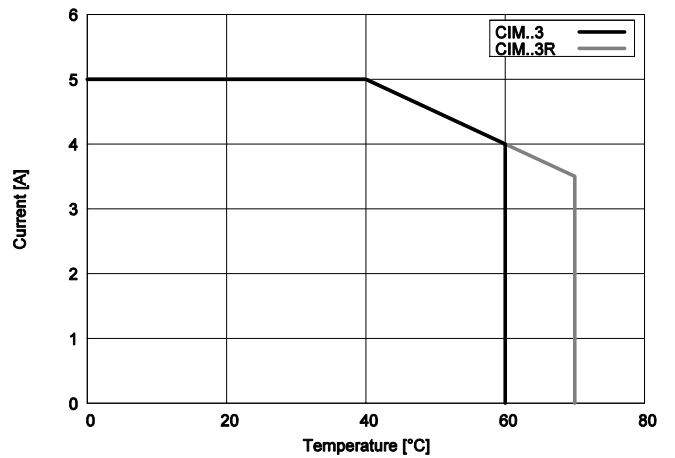

## 7 Application hints

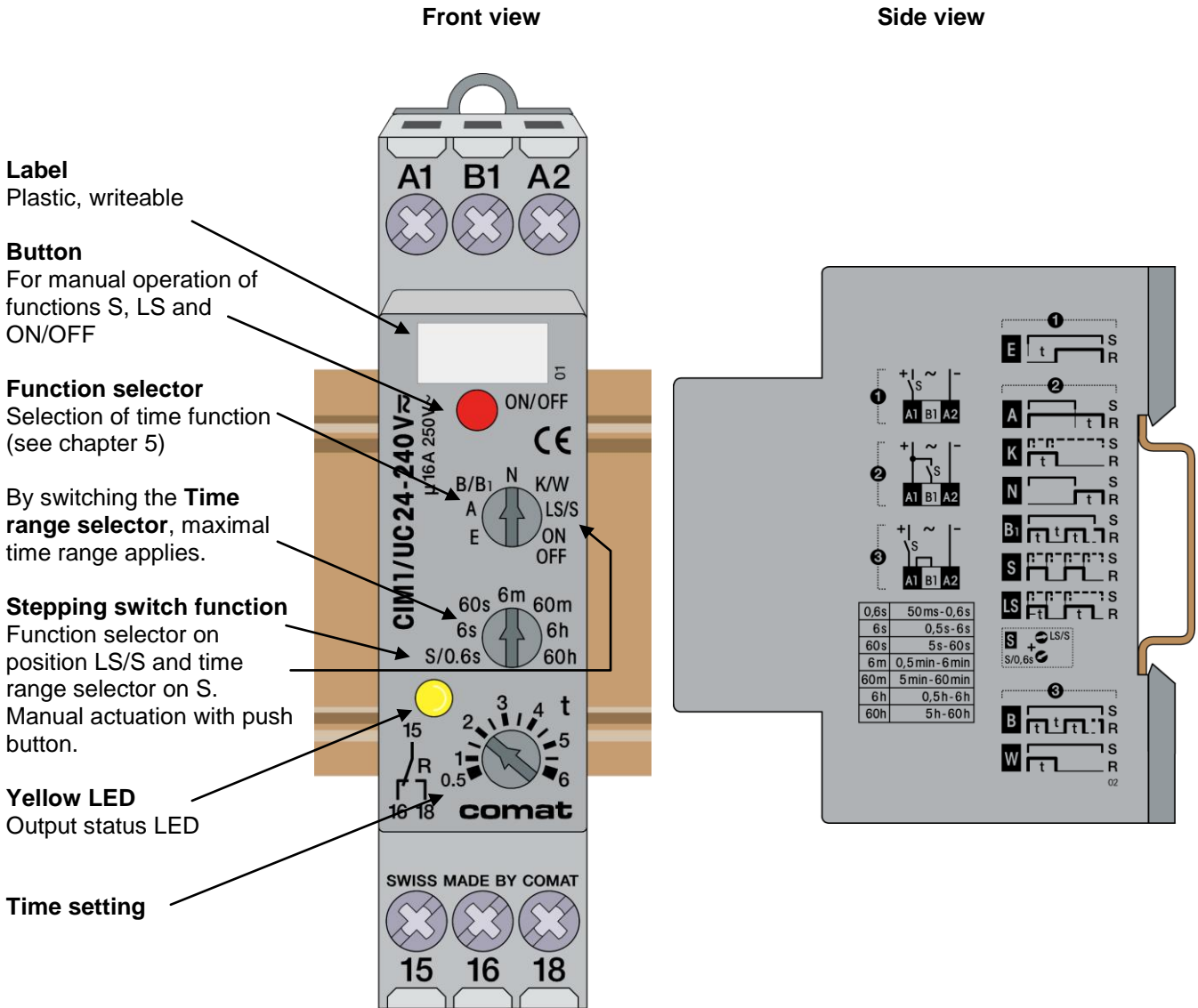

### 7.1 Switching state display

The state of the output relay and the timer is displayed by the yellow LED. A flashing signalizes a running timer.

LED		Relay	Time expires
Not glowing	_____	Off	No
Glowing constantly	=====	On	No
Flashing short	▬▬▬▬▬▬	Off	Yes
Flashing long	▬▬▬▬▬▬	On	Yes

### 8 Dimensions

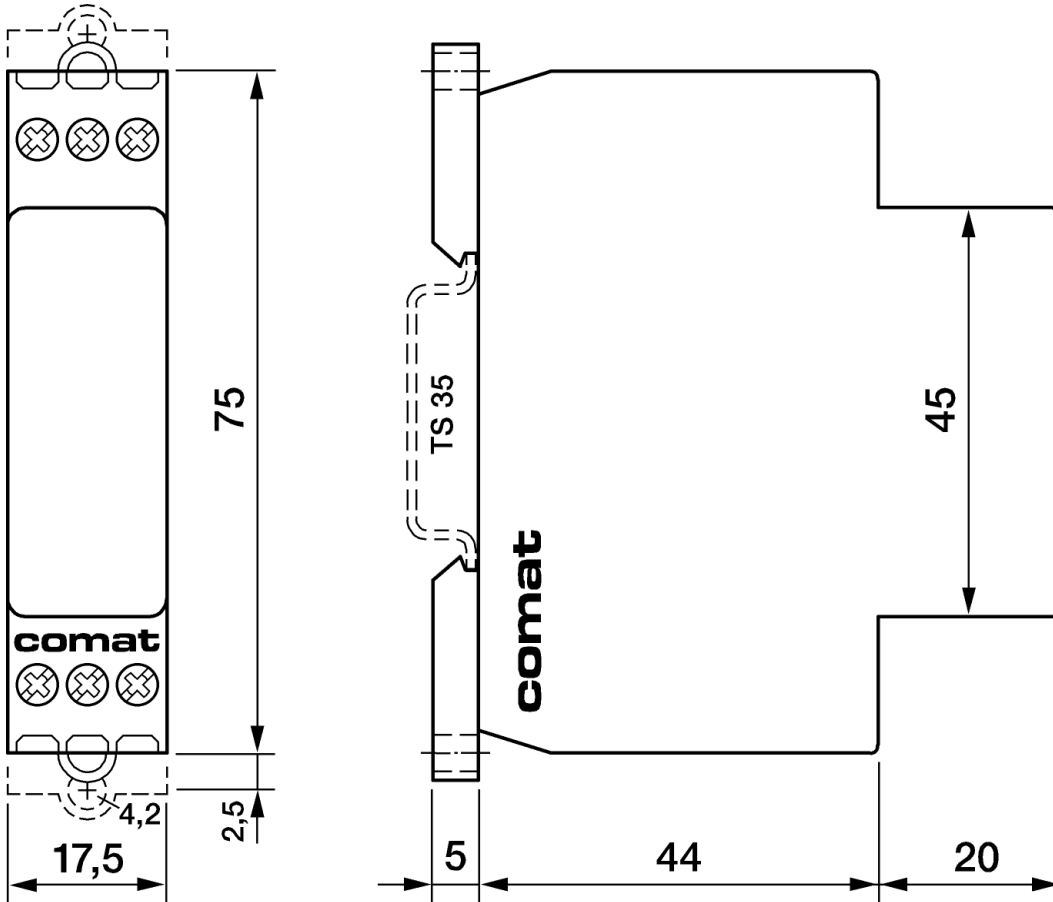

### 9 Standards

Interference immunity

- EN 61000-6-2:2005
- EN 61000-4-2:2001 Level 3 (Air: 8 kV)
- EN 61000-4-4:2004 Level 3 (2 kV)
- EN 61000-4-5:2006 Level 3 (2 kV)

Interference emission

- EN 61000-6-3:2007
- EN 55022:2006 Class B

Safety

- EN 60730-1:2000
- EN 61812-1:1996+A11:1999
- EN 50155:2007

Approbation

UL

Conformities, Identification

CE

### 10 Revision history

Version	Revision date	Responsible	Modifications
25042-31-57-401	18.12.2007	Cp/Pp/Sa	Version 1
25042-31-57-402	15.05.2009	Sa	Revise technical data
25042-31-57-403	12.03.2010	Cp	New diagrams
25042-31-57-404	03.08.2010	Sa	Corrections
25042-31-57-404	29.06.2011	Cp	New names, input voltages
25042-31-57-406	26.10.2011	Cp	CIM14 added